



CAD-572SE/MkII

OPERATING MANUAL

NOTE:

Before installing your new CAD-572SE/MkII, please read this manual carefully as it will inform you of the CAD-572SE/MkII specifications, proper installation procedures and operation procedures. Also included in this manual are guidelines on how to properly service and care for your new CAD-572SE/MkII.

CAD-572-SE/MKII

SINGLE-ENDED MONO-BLOCS

The new CAD-572-SE/MKII single-ended triode mono-blocs are equipped with the Svetlana SV-572-3 tube. This is a brand new design and by all indications a tube that will last up to five years or more in the Cary Audio mono-bloc amplifiers. The basic design of the new CAD-572-SE/MKII is a time proven circuit used in other new Cary Audio triode single-ended designs. These circuit topologies contribute to incredible reliability and enjoyment.

CAD-572-SE/MKII

For the technically minded, a review of the circuit is in order. The new CAD-572-SE/MKII mono-blocs operate in pure class A single-ended. The output stage features the Svetlana SV-572-3, low-mu audio power triode. The Svetlana 572-3 features a thoriated-tungsten filament, hard glass envelope and a massive graphite anode. The 572-3 low-mu design allows for very low distortion in single-ended designs. In the CAD-572-SE/MKII amplifiers bias is provided by direct coupling of the 6BL7 cathode to the grid of the SV-572-3 output triode. The output power is 20 watts class A single-ended triode. The output transformer in the new CAD-572-SE/MKII is an air gap design with full bias running on a continual basis. The output transformer in the CAD-572-SE is the most important component in the amplifier and has been specifically designed by Cary Audio Design for use in the 572's. We have taken the approach in the output transformer design to use oxygen free copper wire. The primary and secondary windings on portions of the output transformer are wound in a bi-filer process with the two inductors interleaving sixteen times. The bi-filer wind (two conductors wound at the same time) will yield the closest balance and coupling of any design currently utilized in vacuum tube output transformers. The E/I laminents used in the special output transformers on the CAD-572's are silicone impregnated hipersil steel contributing to the extremely low loss and a seductive midrange. The above process is similar to the single-ended design air-gap transformers found on all the Cary single-ended output transformers. The CAD-572-SE/MKII does not use any feedback, either global or local. A drive signal is applied to the control grid of the 572-3

output tube from the 6BL7 driver tube operating in a cathode current source configuration. The input tube is a 6SL7 dual-triode configured in a anode current source configuration. This input driver tube is operating in a class A gain stage. The cathode of the input 6SL7 is AC by-passed and coupled to ground.

The power supply in the CAD-572-SE/MKII actually consists of four different supplies. The power transformer is designed to operate at a 200% continuous commercial service at the full rated 20 watt output level. The high voltage power supply section is a full wave center tap configuration (not some cheap voltage doubler as used in many competitors amps) to a PI network. This high voltage section feeds the final output SV-572-3 tube through the air gapped output transformer. Another supply feeds a PI network medium voltage supply for the input and drive 6SL7 and 6BL7 tubes. There are two additional bias supplies to set the operating perimeters of the driver 6BL7 and final output SV-572-3 tube.

A great deal of attention during design of the new CAD-572-SE/MKII's was concentrated on the "overload recovery" ability of the amplifier. The ability of an amplifier to instantly recover from clipping is much more important than is commonly believed. In the power war of amplifier manufactures the mentality is focused on high and then even higher power output to solve the clipping problem. When in reality the most critical aspect is how fast of a recovery an amplifier can achieve after overload. With the incredible dynamic range of live and in turn recorded music, even 2,000 watts of power is not enough. Most of the music being listened to in an average home listening room is only requiring about 3 watts of power. It is on the transients of loud low frequency program material that tremendous signal voltages will appear at the input of the amplifier. It is in this situation that the overload recovery ability of an amplifier is of critical concern. The CAD-572-SE/MKII extols its merits in the ability to handle transients and instantaneously recover from brief or even extended overloads. The 572-SE's will overload symmetrically at any frequency in the audio bandpass.

The CAD-572-SE/MKII will also yield faithful reproduction of extremely low frequencies at full output levels. Power transformer, power supply regulation and output transformer design and careful shaping of the overall frequency response curve all play a very important part in the ability of the

CAD-572-SE/MKII to recover quickly when over loaded. If one were to monitor the high voltage rail voltage (580 VDC) at the anode of the SV-572-3 output tube during soft and also loud music passages it would be found there is no more than a volt or so change from soft to loud passages.

Another technical feature of the new CAD-572-SE/MKII amplifier is stability. The 572-SE's may be operated with no load (without speaker) without damage to the amplifier, output transformer or tubes.

The CAD-572-SE mono amplifiers are built on a textured painted steel chassis with anodized aluminum front panels. The amplifiers are built to perform year after year with trouble free operation. The CAD-5572-SE/MKII's are a classic example of the "CARY" sound.

SPECIFICATIONS

Operating the CAD-572-SE/MKII mono-bloc amplifier is a simple procedure since each unit is designed for long term stability in virtually any home operating situation. Therefore, if the unit is operated outside the parameters outlined in this owner's manual, damage may result. Please read this manual carefully before putting your new CAD-572-SE/MKII Cary Audio Design amplifiers in operation.

The following definitions are applicable to this manual. These definitions must be followed explicitly.

WARNING

HAZARD PRESENTS PERSONAL INJURY OR DEATH

Caution

EQUIPMENT DAMAGE MAY OCCUR BUT NOT PERSONAL INJURY

Note

Proper performance of the amplifier cannot be ensured if disregarded

1.2 Specifications

The following section describes the CAD-572-SE/MKII basic specs. Specifications are subject to change without notice or obligation.

DIMENSIONS: 7"H x 5.5"W x 19"D

WEIGHT: 28 Lb..

CIRCUIT TYPE: Single-End Triode Amplification in Class A

POWER OUTPUT: 20 Watts Triode

INPUT SENSITIVITY: 2 volt for full output

INPUT IMPEDANCE: 150,000 ohms

NOISE AND HUM: 70dB below rated output

FREQUENCY RESPONSE (at one watt output): 15Hz to 23,000Hz + 0 - 0.75dB

TUBES: 1-6SL7 input tube, 1- 6BL7 driver tube, 1- SV-572-3 output tube
1-5R4 Rectifier tube

TRANSFORMERS: 1-EI laminated core power transformer
1-Special air gap output transformer
2-Air gap filter chokes
200% duty cycle on all transformers

RESISTORS: 1% metal film

CAPACITORS: Polystyrene, polypropylene and oil filled

POWER SUPPLY CAPACITORS: 2-1200 MFD @ 450VDC
2- 47 MFD @ 450 VDC
2-47 MFD @ 350 VDC
3- 2 MFD @600 VDC

AC CORD: Detachable 3 conductor 14 gauge

AC POWER REQUIREMENTS: 117/234/240 volts AC 50/60 Hz
222 watts operate

WARM-UP TIME: 3 minutes

BREAK-IN PERIOD: 100 hours of music playing time

FINISH: Textured painted steel chassis with anodized aluminum front panel *** Stainless steel chrome plated chassis optional

1.3 Front Panel Features

AC-ON TOGGLE SWITCH: Turns AC power on in the "up" position.

STAND-BY/OPERATE: Turns on B+ plate voltage in the "up" position

1.4 Rear Apron Features

INPUT: Signal input connection via shielded interconnect cable
** Optional BNC connector for direct coupling model

BIAS POTENTIOMETER: Screw driver adjustment to be set after 10 minutes of warm up to between 110 ma. to 125 ma.

BIAS JACK: 1/4" two (2) conductor jack for DC current test ... tip is meter plus and ring is negative ground. Meter should read between 110 ma. to 125 ma.

SPEAKER OUTPUT: The 5-way binding posts provide the output to the speaker system Red +, Black-

AC: 3 conductor power cord connector

AC power fuse: Use only 2 Amp slo/blow

CAUTION
USE OF ANY OTHER PROTECTION FUSE CAN DAMAGE UNIT

AC FUSE: AC power fuse. Never replace with any other fuse than
2 AMP
SLOW BLOW! 250 VOLT!

CAUTION
NEVER REMOVE/INSERT AC LINE CORD WHEN THE UNIT IS ON

INSTALLATION

This section describes the unpacking and installation procedures for the CAD-572-SE/MKII amplifier.

WARNING
MAKE NO ATTEMPT TO PUT THE CAD-572-SE AMPLIFIER IN SERVICE WITHOUT THE BOTTOM PLATE ATTACHED - CONTACT WITH VOLTAGE IN THE CAD572-SE CAN BE FATAL!!!

2.2 Unpacking

All shipping containers have been specifically designed to protect their contents and special care has been taken to prevent damage under normal shipping conditions. Mishandling should be evident upon inspection of the shipping container. If damage is found after visual inspection, take care not

to destroy the evidence. If necessary, document the damage with photographs and contact the transport carrier immediately.

Carefully remove your new CAD-572-SE/MKII amplifier from its packing carton, and examine it closely for signs of shipping damage. It is recommended to save all original packing cartons to protect your amplifier from damage should you wish to store it or ship it for after sales service.

2.3 Warranty Card

Fill out the enclosed warranty registration card and return to Cary Audio Design within 10 days of original purchase. Keep your original sales slip with the packing cartons should you ever need it for reference. **Failure to register warranty will limit the warranty to one year.**

2.4 Amplifier Placement

In general, the location of your new CAD-572-SE/MKII amplifier is not critical. The best placement in your system is near the speaker system with short lengths of speaker cables. Certain precautions must be taken to ensure optimum performance. Avoid extremely hot locations such as near radiators or other heating units. Keep the top of the CAD-572-SE/MKII's clear of books, paper or other equipment to protect against overheating.

2.5 Power Requirements

The CAD-572-SE designed to operate from house current mains. The design voltage is 117VAC at 50/60 Hz. (Foreign units 220/234240 VAC at 50.60Hz)

2.6 Cables

The speaker cables from the output posts of the CAD-572-SE to the speaker system can be any convenient length your set-up requires. Select speaker cables of sufficient size to preserve the outstanding performance capabilities of your CAD-572-SE/MKII. Heavy gauge #16 wire is suitable for distances

up to 10 feet; #12 for 25 feet. Most audio dealers will have proper speaker cable in stock for this purpose.

OPERATION

Signal input connection is made via the input jack on the rear of the amplifier located next to the output binding posts. The interconnect cables from the output of the preamplifier can be any convenient length your set-up requires. The choice of a high quality interconnect cable is important. Once again, your audio dealer will have the proper cables in stock for this purpose.

3.1 Operation

Your new CAD-572-SE/MKII's are ready for operation after the speaker, interconnect cables and the three tubes have been installed. Tube positions are listed on the sheet in the front of this manual. The speaker impedance switch should be set to the 3-10 ohm (toward the rear) or 10-16 ohm position (toward the front) of the amplifier. You may use either position of this switch without damage to the amplifier or your loudspeakers. You can select for the best sound in your system. Generally the 3-10 ohm position is best suited for most conventional hi-fi loudspeaker systems.

3.2 AC On Power Switch

Simply flip the AC switch up to the ON position (the blue LED will light). Observe that all tubes are lit (filaments).

3.3 Stand-By Operate Switch

In the down position the plate voltage will be in stand/by. Turning the switch to the "up" position will bring up the operating B+ voltage on the plates of the vacuum tubes. The BLUE LED will light when the unit is ready. It is advisable to wait about 1 minute after turning on the AC power switch before placing the stand/by operate switch in the up position. This time will allow the filaments of the tubes to reach full operating temperature.

3.3 Bias setting

Your new CAD-572-SE/MKII amplifiers have been properly biased at the factory. The voltage in your home may vary from the Cary Audio Design factory. Because of this variance in AC power mains it is advisable to check the bias after the amplifiers have warmed up for a few minutes. To check and or adjust the bias a DC current meter is required. This can be a simple analog meter or a digital DVM multimeter. Be certain that you have selected the DC current position on the multimeter. Using the supplied 1/4" male plug with wires and alligator clips be sure to put the orange/red clip to the positive probe. The negative probe from the meter is attached to the black lead. Simply rotate the slotted control on the rear panel of the CAD-572-SE/MKII for a reading of between 110 ma. to as high as 125 ma. Please be certain once again the test meter is reading DC current. If one should use the DC voltage scale improper bias setting will occur and damage may occur to your new CAD-572-SE/MKII amplifier.

3.5 Break In Period

The tubes, capacitors and output transformers take approximately 100 hours of music playing to fully settle in for peak performance. The 572-SE's may seem sterile or thin sounding right out of the box. After the first couple of hours you will notice increased depth and tighter bass. This break in period defies all engineering theory, but is true with most audio amplifiers.

SERVICE AND CARE

WARNING

MAKE SURE AMPLIFIER IS UNPLUGGED FROM AC MAINS

4.1 CAD-572-SE/MKII Care and Cleaning

The chassis of the 572-SE/MKII may be cleaned with a soft rag and Windex (or a similar window cleaner). The frequency of cleaning will be governed by how many hours the CAD-572-SE/MKII is operated and by operating environmental cleanliness.

4.2 Tube Replacement

If it becomes necessary to replace the tubes in the CAD-572-SE/MKII amplifier, a matched set of tubes of the same brand should be used. A new tube kit is available from your Cary Audio dealer. You should get year's from the output tube with everyday usage and many, many years of use from the 6SL7 and 6BL7 input tube. The 5R4 rectifier tube should last up to ten years in the CAD-572-SE/MKII.

1

4.3 Factory Service

Careful consideration has been given to the design of your CAD-572-SE/MKII amplifier to keep maintenance problems to a minimum. However, it is possible that some problems may arise which cannot be cured by tube substitution. At this point we suggest that you contact our Customer Service Department, phone number 1-919-481-4494, to describe your problem in detail. Do not return the amplifier to the factory without a return authorization number from the Customer Service Department. Cary Audio Design will assume no responsibility if the transportation company refuses to pay a damage claim due to improper packing or lack of insurance should the unit be lost in shipment.

WARNINGS

MAKE NO ATTEMPT TO PUT THE CAD-572-SE IN SERVICE OUTSIDE OF THE CABINET. CONTACT WITH HIGH VOLTAGES FOUND IN THE UNIT CAN BE FATAL!!!

COMPLETELY REMOVE AC POWER PLUG FROM THE WALL AND ALLOW 30 MINUTES FOR THE HIGH VOLTAGE CAPACITORS TO DISCHARGE THROUGH BLEEDER RESISTORS BEFORE ATTEMPTING TO CHANGE TUBES OR CLEAN THE INSIDE OF THE AMPLIFIER.

CAUTIONS

NEVER REMOVE/INSERT AC PLUG WHEN THE UNIT IS ON OR THE AC POWER SWITCH IS IN THE "ON" POSITION.

OBSTRUCTION OF THE TOP PORTION OF THE CAD-572-SE WILL RESULT IN TUBES OVERHEATING.

**** OBSERVE DIRECTIONS IN THIS MANUAL ****

NOTES:

572-SE MK-II Tube Placement

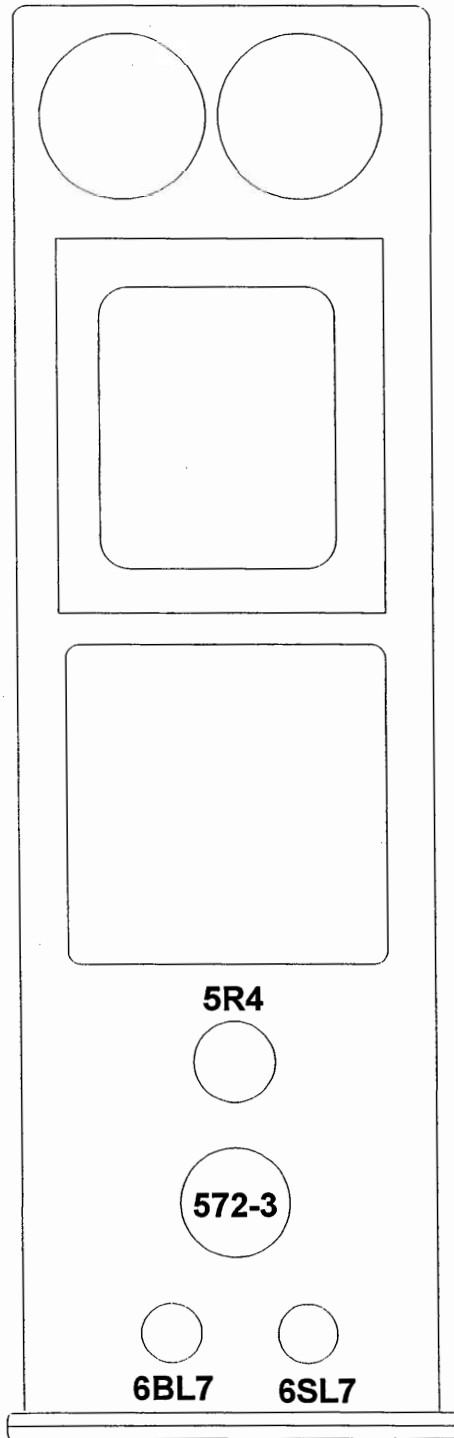

Large pins on SV-572-3 tube MUST be inserted into the large holes in the sockets! These pins are on the front of the amplifier.

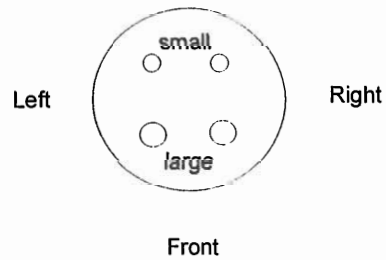

***** WARNING: When installing 572 tubes; Large pins orient towards the front of the chassis. Failure to follow these guidelines will result in severe damage to your equipment.**

572-SE MK-II Bias Adjustment

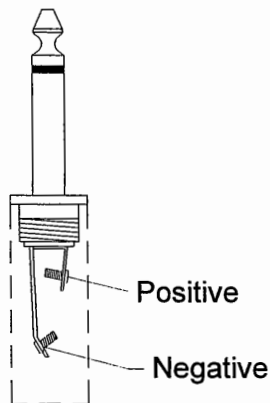
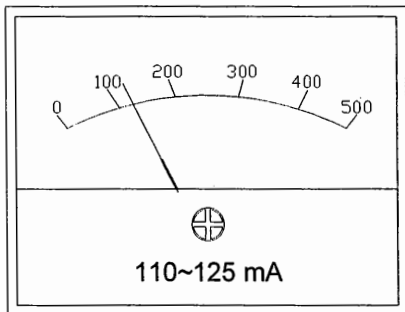
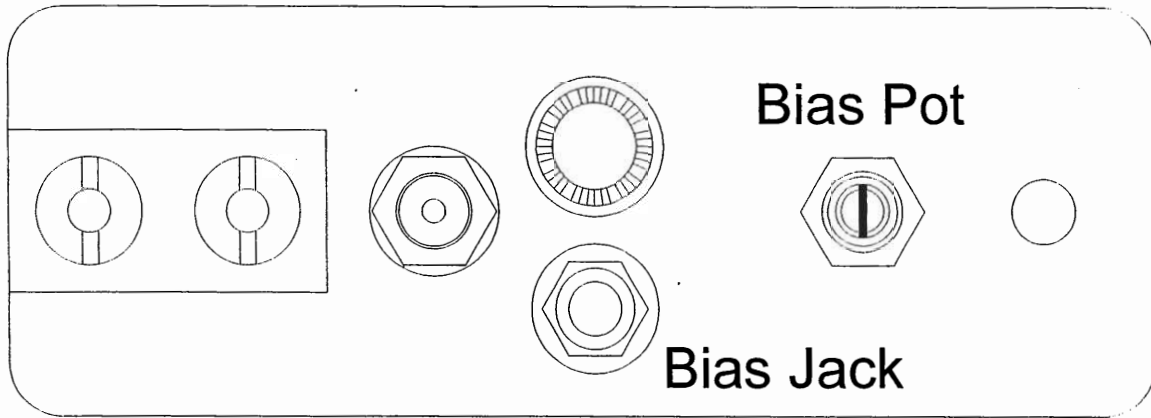

Insert meter plug into bias jack.
Adjust for 110~125mA reading on VOM or DC current meter.
Readjust to after after CAD-572-SE MK-II is warmed up for
10 minutes. Remove plug and enjoy the music!

Note: Bias is factory preset; Bias should be reset when installing replacement SV-572-3 tubes.

Impedance Selector switch

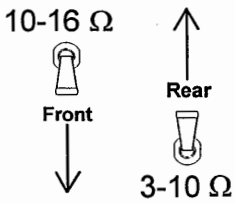
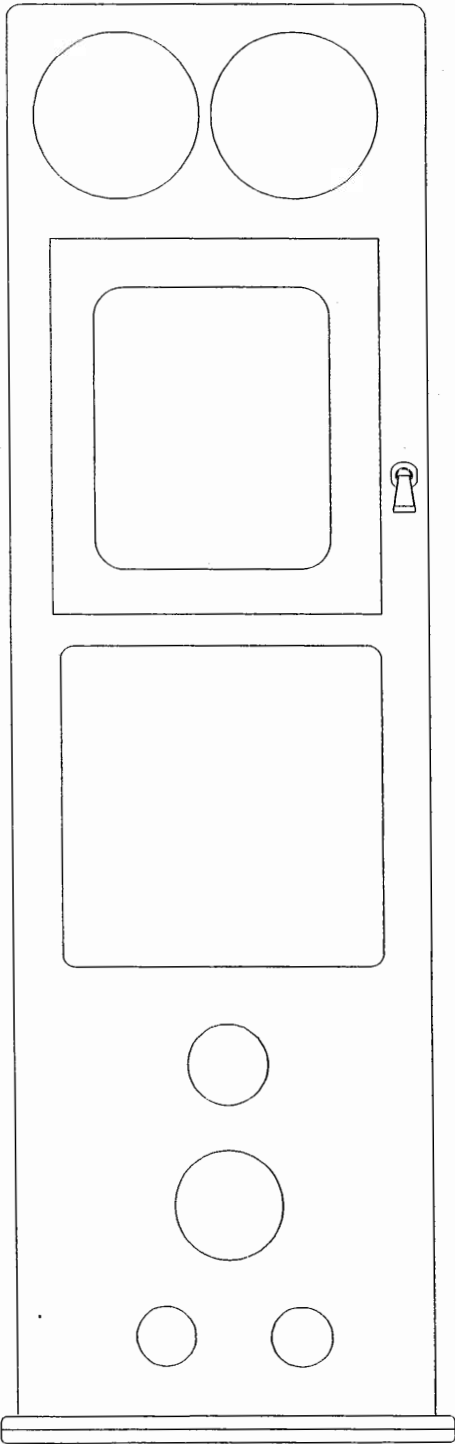

Notes:

Notes:

UNITED STATES LIMITED WARRANTY

Audio Electronic Supply warrants to the original United States purchaser for use in the United States, that this product shall be free from defects in material (except tubes and AF output transistors) or workmanship for three (3) years from the date of the original purchase.

During the warranty period, Audio Electronic Supply will provide free of charge both parts (except tubes and AF output transistors) and labor necessary to correct defects in material or workmanship.

To obtain such warranty service, the original purchaser must:

- (1) Complete and send in the warranty Registration Card.
- (2) Notify Audio Electronic Supply as soon as possible after the discovery of a possible defect:
 - (a) The model number and serial number;
 - (b) The identity of the seller and the approximate date of purchase;
 - (c) A detailed description of the problem, including details on the electrical connection in the associated equipment and the list of such equipment.
- (3) Deliver the product to Audio Electronic Supply or the nearest authorized service facility, or ship the same in its original container or equivalent, fully insured and the shipping charges prepaid.

Correct maintenance, repair and use are important to obtain performance from this product. Therefore, carefully read the Instruction Manual. This warranty does not apply to any defect that Audio Electronic Supply in its sole discretion determines is due:

- (1) Improper maintenance or repair, including the installation of parts or accessories that does not conform to the quality and the specifications of the original parts.
- (2) Misuse, abuse, neglect or improper installation.
- (3) Accidental or incidental damage.

WARRANTY DISCLAIMER

Except for the express warranties stated herein, Audio Electronic Supply disclaims all other warranties including, without limitation, all implied warranties of merchantability and fitness for a particular purpose.

EXCLUSIVE REMEDY

Notwithstanding the foregoing, the purchaser's exclusive remedy for any breach of warranty, express or implied, is limited to the repair or replacement of the defective unit or the refund of the purchase price, at the option of Audio Electronic Supply. Under no circumstances is Audio Electronic Supply liable for incidental or consequential damages. Any implied warranties imposed by law terminate one (1) year from the date of purchase.

FOREIGN PURCHASERS

Audio Electronic Supply warrants its merchandise to purchasers in the United States for use in the United States. It provides no other warranties. If you are a foreign purchaser, consult with your dealer to determine whether your dealer provides any warranty.

The foregoing constitutes Audio Electronic Supply's entire obligation with respect to this product, and the original purchaser and any user or owner shall have no other claim for incidental or consequential damages. Some states do not allow the exclusion or limitation of incidental or consequential damages, so the above limitation and exclusion may not apply to you.

This warranty gives legal rights and you may also have other rights which vary from state to state.

CARY

Audio Design

111-A Woodwinds Industrial Court
Cary, NC 27511
USA

Phone: 1-919-481-4494

Fax: 1-919-460-3828

www.caryaudio.com

info@caryaudio.com