



CAD-300SEI SPECIAL LX-20 VERSION

OPERATING MANUAL

CARY • AUDIO • DESIGN

111-A WOODWINDS INDUSTRIAL COURT, CARY, N.C. 27511 (919) 481-4494 FAX (919) 460-3828

NOTE:

Before installing your new CAD-300SEI LX-20, please read this manual carefully. This manual will inform you of the CAD-300SEI LX-20 specifications, proper installation procedures. Also included in this manual are guidelines on how to properly service and care for your new CAD-300SEI LX-20.

Large pins on KR-300B LXS tube MUST
be inserted into the large holes in the sockets!

These pins are on the right side of the amplifier in the following products:

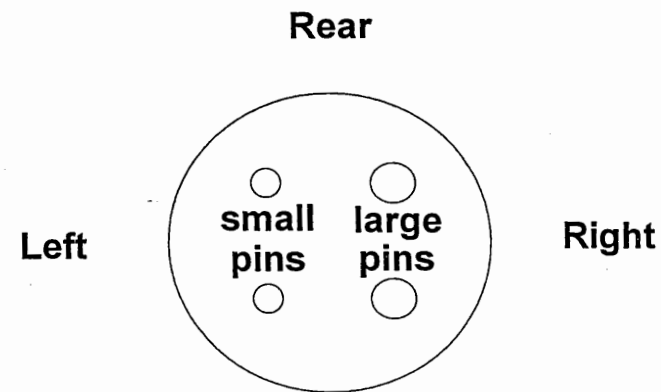

Front
CAD 300-SE LX-20
CAD 300-SEI LX-20
CAD 300-B LX

These pins are on the front of the amplifier in the following products:

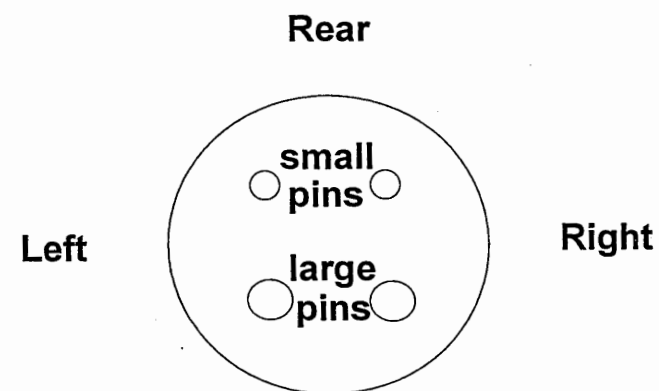

Front
CAD 805c
CAD 211M
Any older Cary Audio Design products

UNITED STATES LIMITED WARRANTY

Cary Audio Design, Inc. warrants to the original United States purchaser for use in the United States that this product shall be free from defects in material (except tubes and AF output transistors) or workmanship for:

Models CAD-211M, SLM-200 and the CAD-805, Five (5) years from the date of the original purchase.
Amplifiers and Preamplifiers, Three (3) years from the date of the original purchase.
Digital, One (1) year from date of original purchase.

During the warranty period, Cary Audio Design, Inc. or an authorized Cary Audio Design, Inc. service facility will provide free of charge both parts (except tubes and AF output transistors) and labor necessary to correct defects in material or workmanship.

To obtain such warranty service, the original purchaser must:

- (1) Complete and send in the warranty Registration Card.
- (2) Notify Cary Audio Design, Inc. as soon as possible after the discovery of a possible defect:
 - (a) The model number and serial number;
 - (b) The identity of the seller and the approximate date of purchase;
 - (c) A detailed description of the problem, including details on the electrical connection in the associated equipment and the list of such equipment.
- (3) Deliver the product to Cary Audio Design, Inc. or the nearest authorized service facility, or ship the same in its original container or equivalent, fully insured and the shipping charges prepaid.

Correct maintenance, repair and use are important to obtain optimum performance from this product. Therefore, carefully read the Operating Manual. This warranty does not apply to any defect that Cary Audio Design in its sole discretion determines is due to:

- (1) Improper maintenance or repair, including the installation of parts or accessories that do not conform to the quality and the specifications of the original parts.
- (2) Misuse, abuse, neglect or improper installation.
- (3) Accidental or incidental damage.

WARRANTY DISCLAIMER

Except for the express warranties stated herein, Cary Audio Design, Inc. disclaims all other warranties including, without limitation, all implied warranties of merchantability and fitness for a particular purpose.

EXCLUSIVE REMEDY

Notwithstanding the foregoing, the purchaser's exclusive remedy for any breach of warranty, express or implied, is limited to the repair or replacement of the defective unit or the refund of the purchase price, at the option of Cary Audio Design, Inc.. Under no circumstances is Cary Audio Design, Inc. liable for incidental or consequential damages. Any implied warranties imposed by law terminate one (1) year from the date of purchase.

FOREIGN PURCHASERS

Cary Audio Design, Inc. warrants its merchandise to purchasers in the United States for use in the United States. It provides no other warranties. If you are a foreign purchaser, consult with your dealer to determine whether your dealer provides any warranty.

The foregoing constitutes Cary Audio Design, Inc. entire obligation with respect to this product, and the original purchaser and any user or owner shall have no other claim for incidental or consequential damages. Some states do not allow the exclusion or limitation of incidental or consequential damages, so the above limitation and exclusion may not apply to you.

This warranty gives legal rights and you may also have other rights which vary from state to state.

*** Failure to follow these instructions will result in damage to your equipment ***

Notes:

CAD-300SEI LX-20

Single Ended Stereo Integrated Amplifier

INTRODUCTION

Congratulations! You have purchased one of the most exotic vacuum tube audio integrated amplifiers available. The CAD-300SEI LX-20 is the result of nine years of refinement to the CAD-300SE mono blocks. These are the amplifiers that started the revolution in high-end audio in 1990. This pure class A, triode-tube, single-ended integrated amplifier is the standard by which all others should be judged.

There are moments when the art and technology come together to make a legend. Among discerning audio lovers, the new CAD-300SEI LX-20 is such a legend. Experience the CAD-300SEI LX-20's. We believe they will change the way you listen to music. *Forever!*

CAD-300SEI LX-20 Technical Description

For the technically minded, a review of the circuit is in order. The new CAD-300SEI LX-20 operates in a pure class A single-ended mode. The output stage features the new KR Enterprise's 300BXLS low-mu audio power triode. The output power is 20 watts class A single-ended triode. The output transformer in the new 300SEI LX-20 is an air gap design with full bias running on a continual basis. The output transformer in the CAD-300SEI LX-20 is the most important component in the amplifier and has been specifically designed by Cary Audio Design for use in the 300SEI LX-20's. We have taken the approach in the output transformer design to use oxygen-free copper wire. The primary and secondary windings on portions of the output transformer are wound in a bi-filer process with the two inductors interleaving sixteen times. The bi-filer wind (two conductors wound at the same time) will yield the closest balance and coupling of any design currently utilized in vacuum tube output transformers. The E/I laminents used in the special output transformers on the CAD-300SEI LX-20 amplifiers are silicone-impregnated hipersil steel, contributing to the extremely low loss and a seductive midrange. The above process is similar to the single-ended design air-gap transformers found on all the Cary single-ended output transformers.

The input source signal is directly applied to a class A voltage gain circuit using a 6SN7 tube. The additional 6SN7 tubes functions as a current source and low-impedance driver to the KR-300BXLS output tube. The driver signal is coupled to the final output 300BXLS control grid via an oil-filled .22MFD @ 600VDC capacitor. A separate low-impedance bias voltage supply establishes the final output tube conduction current. In the CAD-300SEI LX-20 the tube operates at 55 watts input power (550VDC X 100mA.).

The power supply in the CAD-300SEI LX-20 actually consists of four different supplies. The power transformer is designed to operate at 200% continuous commercial service at the full rated 20-watt output level. The high-voltage power supply section is a full wave center tap configuration (not some cheap voltage doubler as used in many competitors' amps) to a PI filter choke, capacitor network. This high-voltage section feeds the final output KR 300BXLS tube through the air-gapped output transformer. Another supply feeds the PI network medium-voltage supply for the input and drive 6SN7 tubes. There is an additional DC supply to supply DC to all the filaments of all the tubes in the amplifier. The DC filament supply will prevent AC ripple from capacitively being coupled to the electrodes of the input and output tubes.

Enjoy the music, and of course, please read this manual for a complete understanding of trouble free operation.

SPECIFICATIONS

Operating the CAD-300SEI LX-20 integrated amplifier is a simple procedure since each unit is designed for long term stability in virtually any home operating situation. Therefore, if the unit is operated outside the parameters outlined in this owner's manual, damage may result. Please read this manual carefully before putting your new Cary Audio Design CAD-300SEI LX-20 in operation.

The following definitions are applicable to this manual. These definitions must be followed explicitly.

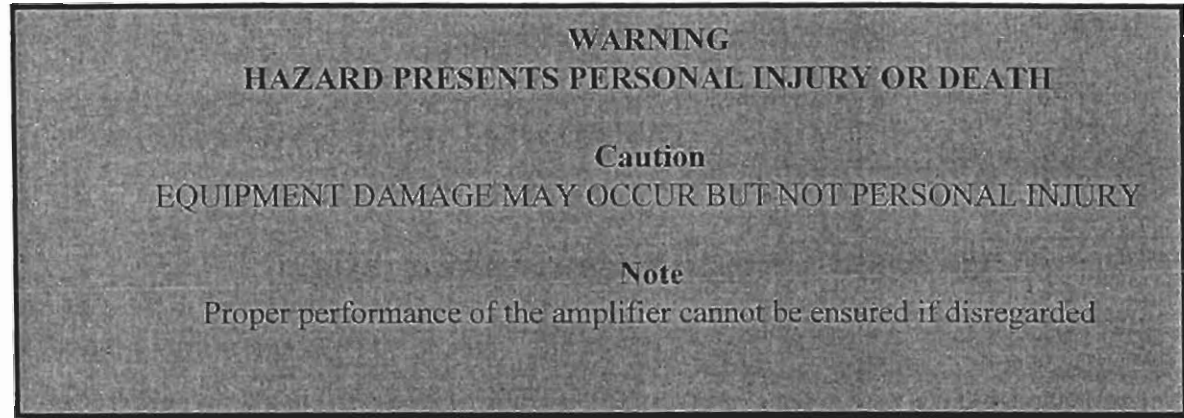

1.2 Specifications

The following section describes the CAD-300SEI LX-20 basic specifications. Specifications are subject to change without notice or obligation.

DIMENSIONS: 8"H x 14"W x 14"D

WEIGHT: 42 Lb..

CIRCUIT TYPE: Single Ended, Class A

INPUTS: CD, AUX1, AUX2

POWER OUTPUT: 4/8 ohms = 20 watts/CH

S/N: 90dB below rated power output

FREQUENCY RESPONSE (11 watt): 23 - 20,000 Hz (+0 - 0.75dB)

HEADPHONE OUTPUT: 4-50 ohm compatible 1/4" 3 circuit jack

OUTPUT TRANSFORMERS: 200% duty cycle
Air gapped, wound with OFC
copper wire, wax impregnated

RESISTORS: 1% metal film

WIRE: Silver double "E" teflon

COUPLING CAPS: Oil filled

POWER SUPPLY CAPACITORS: 2 - 1200MFD @ 450VDC,

Notes:

Notes:

WIRING: Point-to-point

LINE INPUT: 3 switchable selections

SPEAKER POSTS: 5-way Copper

TUBE SOCKETS: Ceramic silver pins

ADDITIONAL FEATURES: Soft shoe feet
Detachable power cord

TUBE COMPLIMENT: 2 - 300B triode output tubes
1 - 6SN7 input tube
2 - 6SN7 driver tubes

WARM-UP TIME: 3 minutes

BREAK-IN PERIOD: 100 hours of music playing time

FINISH: Stainless steel chrome chassis with
high gloss anodized black front panel.

1.3 Front Panel Features

AC-ON SWITCH: Turns AC power on in the "up" position

INPUT SELECTOR: Selection of line inputs (CD, AUX1 and AUX2)

LISTENING LEVEL: Dual precision potentiometer controlling volume of
both channels

BALANCE: Dual precision potentiometer controlling the balance between
left and right channels

HEADPHONE: 3 conductor stereo headphone jack for low impedance
headphones

OUTPUT SELECTOR: Switches amplifier output from speakers to head-
phones. When blue LED lights, the headphone jack is
activated. (Located on top right of chassis)

1.4 Rear Apron Features

INPUTS: Signal input connection via shielded interconnect cable

SPEAKER OUTPUT: Copper 5-way binding posts provide the output to the
speaker system.

POWER CORD: 3 conductor shielded power cord to A.C. power mains.

CAUTION
USE OF ANY OTHER PROTECTION FUSE CAN DAMAGE UNIT
REMOVE POWER CORD BEFORE CHANGING FUSES

A.C. FUSE: AC power fuse. Never replace with any other fuse than **2 AMP SLOW BLOW!** 250 VOLT

TUBE FUSE: 300B tube fuse. Never replace with any other fuse than **1/4AMP FAST BLOW!**

CAUTION
NEVER REMOVE/ INSERT AC LINE CORD WHEN THE UNIT IS ON

INSTALLATION

This section describes the unpacking and installation procedures for the CAD-300SEI LX-20 stereo amplifier.

WARNING
MAKE NO ATTEMPT TO PUT THE CAD-300SEI LX-20 AMPLIFIER IN SERVICE WITHOUT THE BOTTOM PLATE ATTACHED - CONTACT WITH VOLTAGE IN THE CAD-300SEI LX-20 CAN BE FATAL!!!

2.2 Unpacking

Carefully remove your new amplifier from its packing carton, and examine it closely for signs of shipping damage. It is recommended to save all original packing cartons to protect your amplifier from damage should you wish to store it or ship it for after-sales service.

All shipping containers have been specifically designed to protect their contents and special care has been taken to prevent damage under normal shipping conditions. Mishandling should be evident upon inspection, take care not to destroy the evidence. If necessary, document the damage with photographs and contact the transport carrier immediately.

2.3 Warranty Card

Fill out the enclosed warranty registration card and return to Cary Audio Design, Inc. within 10 days of original purchase. Keep your original sales slip with the packing cartons should you ever need it for reference. **Failure to register warranty will limit the warranty to one year.**

2.4 Amplifier Placement

In general, the location of your new CAD-300SEI LX-20 amplifier is not critical. The best placement in your system is near the speaker system with short lengths of speaker cables. Certain precautions must be taken to ensure optimum performance. Avoid extremely hot locations such as near radiators or other heating units. Keep the top of the CAD-300SEI LX-20 clear of books, paper or other equipment to protect against overheating.

300sei LX-20 Bias Adjustment

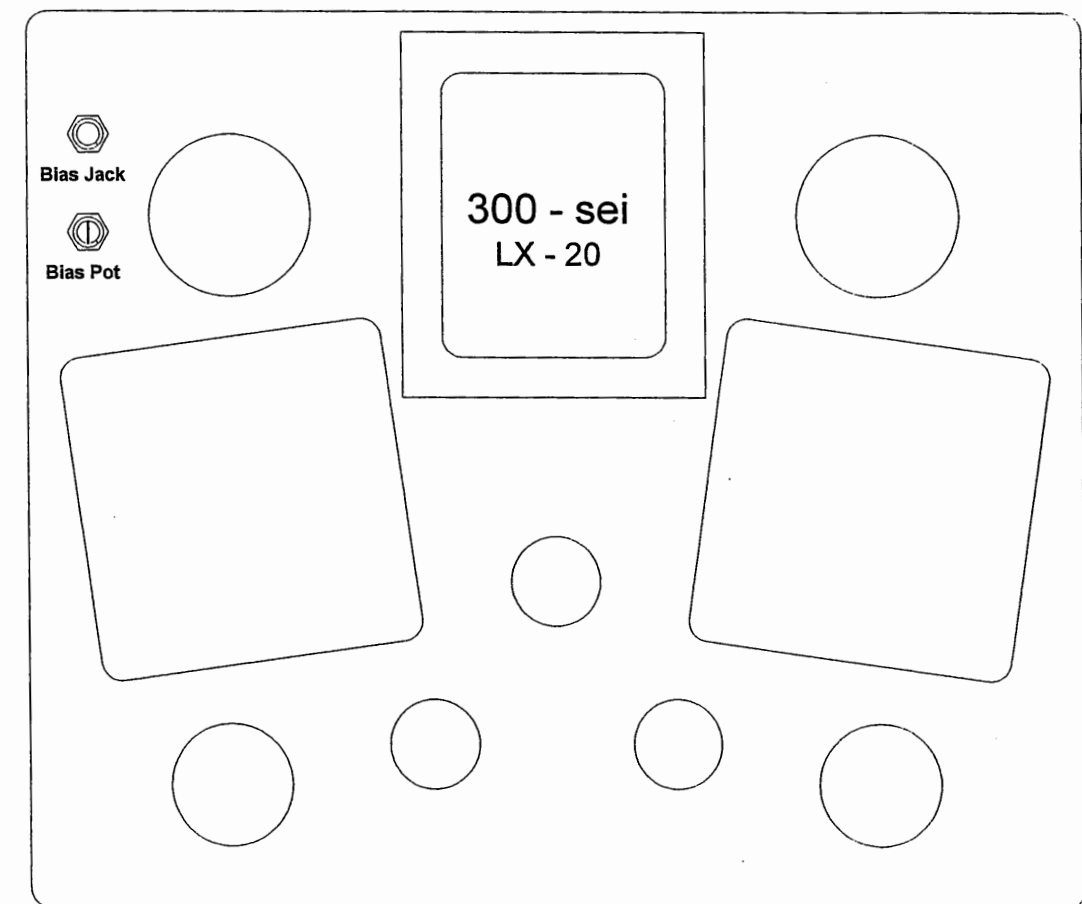
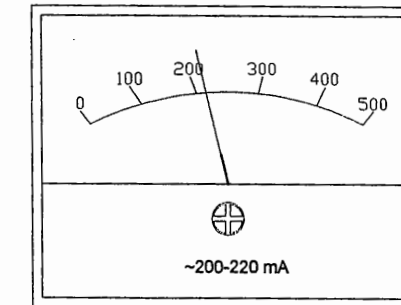
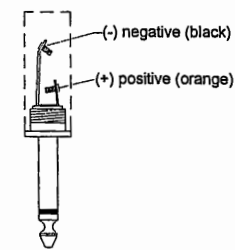

Insert meter plug into bias jack.
adjust for ~200 - 220mA (+-10mA)
reading on VOM or DC current meter.

Note: Bias is factory preset, it should be checked when installing replacement KR-300B-XLS tubes.

300sei Tube Placement

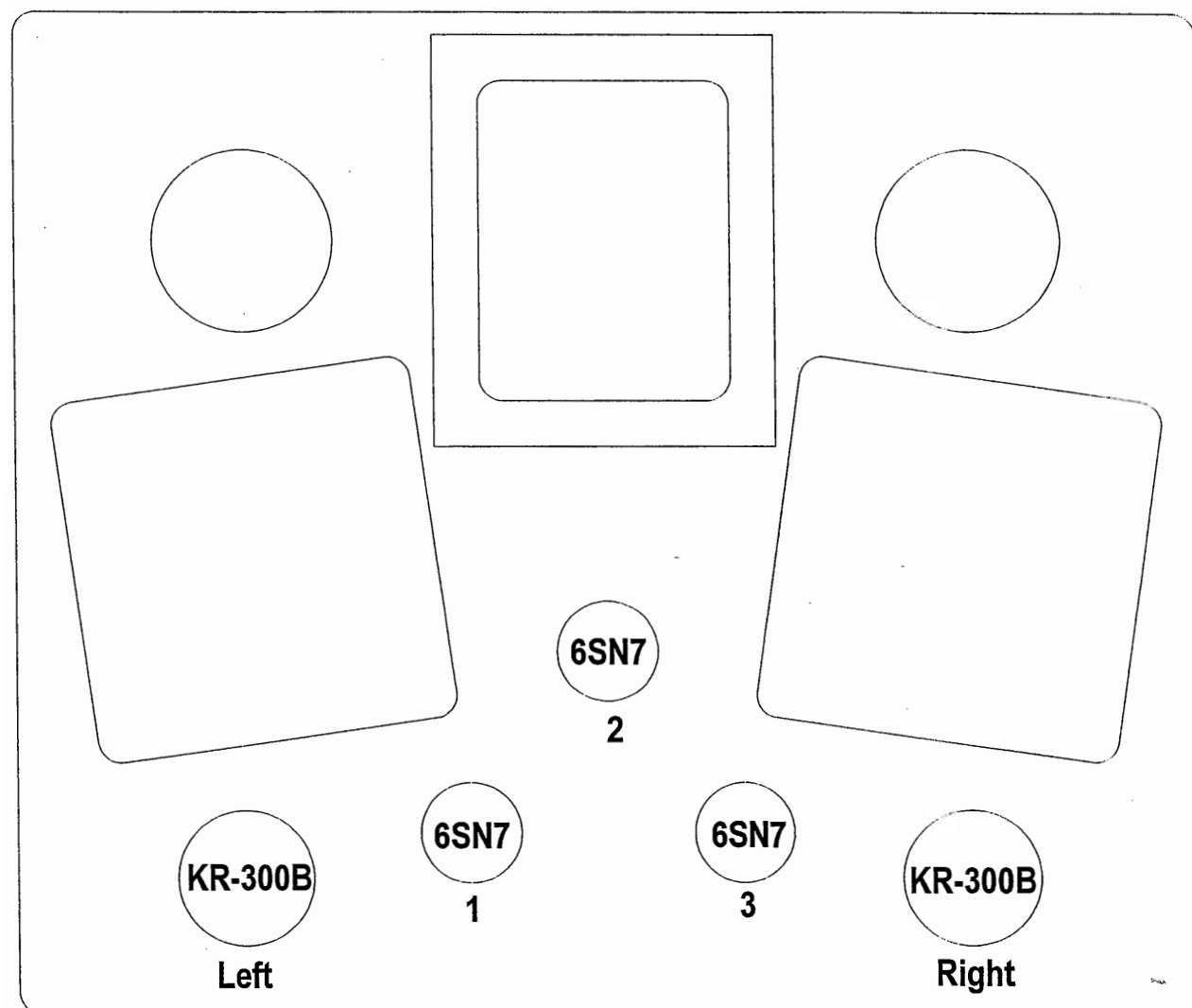

Large pins on KR-300B tube **MUST**
be inserted into the large holes in the sockets!
These pins are on the right side of the amplifier.

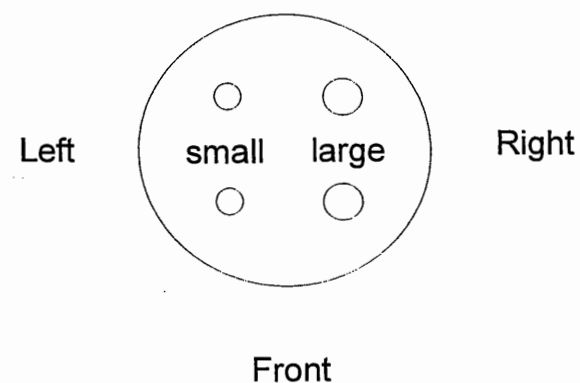

2.5 Power Requirements

The CAD-300SEI LX-20 is designed to operate from house current mains. The design voltage is 117VAC at 50/60Hz. (Foreign units 220 VAC at 50/60Hz)

2.6 Cables

The speaker cables from the output posts of the CAD-300SEI LX-20 to the speaker system can be any convenient length your set-up requires. Select speaker cables of sufficient size to preserve the outstanding performance capabilities of your CAD-300SEI LX-20. Heavy gauge #16 wire is suitable for distances up to 10 feet; #12 for 25 feet. Most audio dealers will have proper speaker cable in stock for this purpose.

OPERATION

Signal input connections is made via the input jack on the rear of the CAD-300SEI LX-20 located next to the output binding posts. The interconnect cables from the output of the preamplifier can be any convenient length your set-up requires. The choice of a high quality interconnect cable is important. Once again, your audio dealer will have the proper cables in stock for this purpose.

3.1 Operation

Your new CAD-300SEI LX-20 is ready for operation after the speaker, interconnect cables, and the tubes have been installed. Refer to the tube outline drawing inserted in this manual for tube placement.

3.2 AC On Power Switch

Simply push the AC rocker switch on the ON position. Observe that the blue LED lights and all tubes are lit (filaments).

3.3 Break In Period

The tubes, capacitors and output transformers take approximately 100 hours of music playing to fully settle in for peak performance. The CAD-300SEI LX-20 may seem sterile or thin sounding right out of the box. After the first couple of hours you will notice increased depth and tighter bass. This break in period defies all engineering theory, but is true with most audio amplifiers.

SERVICE AND CARE

4.1 CAD-300SEI LX-20 Care and Cleaning

The chassis of the CAD-300SEI LX-20 may be cleaned with a soft rag and Windex ®(or a similar window cleaner). The frequency of cleaning will be governed by how many hours the CAD-300SEI LX-20 is operated and by operating environmental cleanliness.

4.2 Tube Replacement

If it becomes necessary to replace the tubes in the CAD-300SEI LX-20 integrated amplifier, a matched set of tubes of the same brand should be used. A new tube kit is available from Cary Audio Design, Inc. You should get years from the 300B output tube with everyday usage and many, many years of use from the 6SN7 & 6SN7 tube's.

WARNING

Make sure amplifier is unplugged from AC mains

4.3 Factory Service

Careful consideration has been given to the design of your CAD-300SEI LX-20 to keep maintenance problems to a minimum; however, it is possible that some problems may arise which cannot be cured by tube substitution. After reading the Troubleshooting Guide at the end of this manual, we suggest that you contact our Customer Service Department at phone number (919) 481-4494 to describe your problem in detail. **Do not return the CAD-300SEI LX-20 to the factory without a Return Authorization Number from the Customer Service Department.** Cary Audio Design, Inc. will assume no responsibility if the transportation company refuses to pay damage claim due to your improper packing or lack of insurance should the unit be lost in shipment.

WARNINGS

Make no attempt to put the CAD-300SEI LX-20 in service outside of the cabinet - Contact with high voltages found in the unit can be fatal!!!

Completely remove AC power plug from the wall and allow 30 minutes for the high voltage capacitors to discharge through bleeder resistors before attempting to change tubes or clean the inside to the preamplifier.

CAUTIONS

Never remove/insert AC plug when the unit is on or the AC power switch is in the "ON" position

Obstruction of the top portion of the CAD-300SEI LX-20 will result in tubes overheating

*****OBSERVE DIRECTIONS IN THIS MANUAL*****

PROPRIETARY RIGHTS: Cary Audio Design, Inc. has proprietary rights in the design and components of its units. While the purchaser is entitled to use the unit for its intended purpose, use of the unit for copying, imitation, or reverse engineering is a violation of these proprietary rights and is forbidden.

Large pins on KR-300B LXS tube **MUST** be inserted into the large holes in the sockets!

These pins are on the right side of the amplifier in the following products:

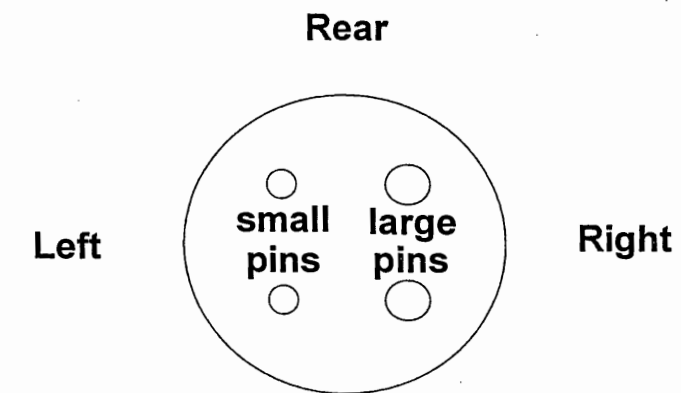

Front

CAD 300-SE LX-20
CAD 300-SEI LX-20
CAD 300-B LX

These pins are on the front of the amplifier in the following products:

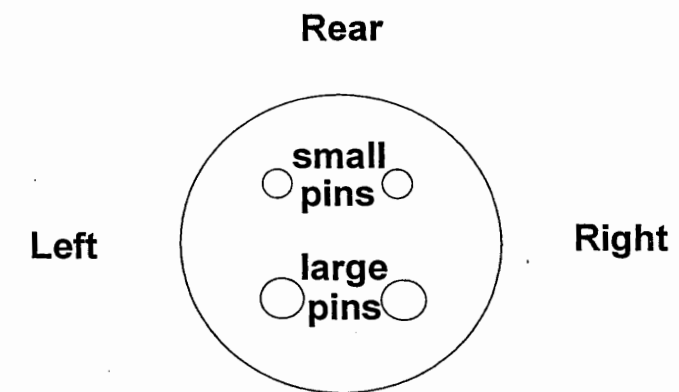

Front

CAD 805c
CAD 211M
Any older Cary Audio Design products

***** Failure to follow these instructions will result in damage to your equipment *****